

FAN COIL

ROOM AIR CONDITIONER

OPERATION MANUAL



HEAT & COOL MODEL

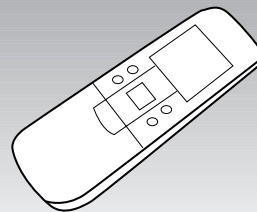
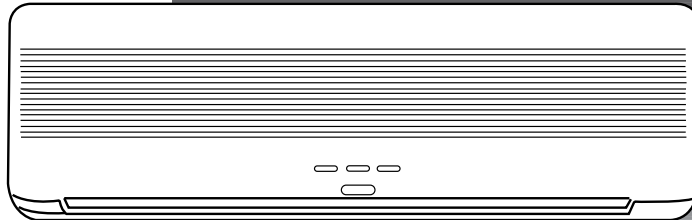



*KEEP THIS OPERATION MANUAL FOR FUTURE REFERENCE



CONTENTS





PRECAUTIONS	2	TIMER OPERATION.....	19
NAME AND FUNCTION OF PARTS	6	SLEEP OPERATION.....	20
PREPARTION.....	10	AIR CLEAN OPERATION.....	21
AUTOMATIC OPERATION.....	12	CARE AND MAINTENANCE.....	22
MODE OPERATION(COOL, DRY, FAN, HEAT).....	14	TROUBLE SHOOTING	24
TIME/TEMP. ADJUSTMENT.....	16	OPERATION DETAILS	26
AIR DIRECTION ADJUSTMENT.....	17		

PRECAUTIONS

- Before using the appliance, read these "PRECAUTIONS" thoroughly and operate in the correct way.
- The instructions in this section all relate to safety; be sure to maintain safe operating conditions.
- "CAUTION" and "WARNING" have the following meanings in these instructions:

 WARNING!	This mark indicates procedures which, if improperly performed, might lead to the death or serious injury of the user.
 CAUTION!	This mark indicates procedures which, if improperly performed, might possibly result in personal harm to the user, or damage to property.

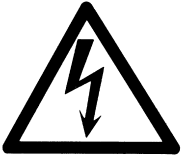
Safety Symbols	
	△The triangular symbol indicates WARNING and CAUTION items.
	⊘This symbol indicates prohibited operations. The prohibited action is indicated both within the symbol, and in nearby explanations.
	●This symbol indicates instructions regarding operations which are to be performed by the user.

 DANGER	
<p>Do not attempt to install this air conditioner by yourself.</p> <p>●Consult authorized service personnel for all installations.</p>	
<p>Consult authorized service personnel for any repairs.</p> <p>●Do not attempt to remove parts, or service the unit yourself, since you may be exposed to dangerous electrical shock. This appliance contains no user-serviceable parts.</p>	
<p>When moving, consult authorized service personnel for disconnection and installation of the unit .</p>	

PRECAUTIONS



DANGER

Do not stay in direct cooling airflow for long periods.

- Excessive direct exposure to chilled air could be bad for your health.
- Be especially careful when going to bed, and in rooms where infants, aged, or sick people are staying.



Do not insert fingers or objects into the outlet port or indoor unit front panel.

- A fan operates at high speed inside the unit, and personal injury could result.
- Be particularly careful regarding small children.



Do not start and stop air conditioner operation by disconnecting the power cord and so on.

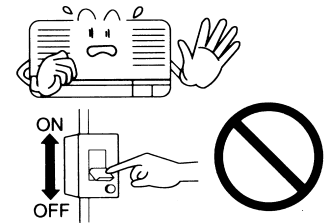

Take care not to damage the power cord.

- Do not stand heavy items on the power cord, or allow it to be pulled. Such treatment could damage the insulation, resulting in fire hazard and electrical shock.



WARNING!

If the power supply cord of this air conditioner is damaged, it must be replaced by the manufacturer or its authorized service personnel only in order to avoid a safety hazard.

In the event of a malfunction (burning smell, etc.), immediately stop operation, disconnect the power plug, and consult authorized service personnel.

- Continuing to operate the unit under such conditions could lead to hazard of fire or electrical shock.



PRECAUTIONS



CAUTION

Provid occasional ventilation during use.

- Be careful to provide adequate ventilation particularly when using the unit in combination with other heating apparatus.
- Insufficient ventilation could lead to oxygen starvation.

Do not direct air flow at fireplaces or heating apparatuses.

- Direct air blowing on fires could result in improper combustion or fire.

Do not climb on, or place objects on, the air conditioner.

- Personal injury could result from a falling object, or if the unit tips over.
- Do not hang on or cover the air conditioner.

Do not set flower vases or water containers on top of air conditioners.

- Water leaking inside the unit could damage electrical insulation, leading to danger of electrical shock.

Do not expose the air conditioner directly to water.

- Electrical insulation could be damaged, resulting in electrical shock.

Do not operate the air conditioner with wet hands.

- Electrical shock could result.

Do not pull power cord.

- Pulling on the cord to disconnect the plug could damage the wires inside the cord, resulting in heat or fire.

Always turn off power and disconnect the power plug whenever cleaning the air conditioner or changing the air filter.

- A fan operates at high speed inside the unit, and personal injury could result.

Turn off power source when not using the unit for extended periods.

Check the condition of the installation for damage.

- After lengthy use, arrange for visit by authorized service personnel to check installation condition.

Take precautions to prevent infants from accidentally swallowing batteries.

- A battery can be very harmful if swallowed. If an infant accidentally swallows a battery, make the infant eject it, and consult your physician.

Do not place animals or plants in the direct path of the air flow.

- Lengthy exposure to direct Cooling airflow could have adverse influence on plants or animals.



CAUTION

<p>Do not drink the water drained from the air conditioner.</p>	<p>Do not use in applications involving the storage of foods, plants or animals, precision equipment, or art works.</p> <ul style="list-style-type: none">●The quality of the stored items may deteriorate.
<p>Take out the batteries from the remote control unit when not using for a long time.</p> <ul style="list-style-type: none">●Take out the batteries to prevent troubles caused by battery liquid leakage.●If leaking battery fluid comes in contact with your skin, eyes, or mouth, immediately wash with copious amounts of water, and consult your physician.	<p>Do not touch the heat exchanger radiator fins.</p> <ul style="list-style-type: none">●Personal injury could result.●Be particularly careful when cleaning.●Bending or damage to the fins will affect the efficiency of the unit.
<p>Always operate with the air filter installed.</p> <ul style="list-style-type: none">●Operating the unit without the air filter could cause excessive dirt to collect on internal parts, leading to malfunction.	<p>Do not block or cover the front panel and outlet port.</p> <ul style="list-style-type: none">●Obstructing the ports will reduce operating efficiency, leading to improper operation and possible damage.
<p>Install the indoor unit and remote control unit at least one meter from any television sets or radio.</p> <ul style="list-style-type: none">●Signal radiation could be induced into the system to give erroneous operation.	<p>Avoid installing the air conditioner near a fireplace or other heating apparatus.</p> <ul style="list-style-type: none">●Exposure to excessive heat could result in deformation of the outer case.
<p>When installing the indoor unit and outdoor unit , take precautions to prevent access by infants.</p> <ul style="list-style-type: none">●Unexpected accidents could occur.	<p>Be sure to attach the front panel securely.</p>
<p>Do not inflammable gases near the air conditioner.</p>	

NAME AND FUNCTION OF PARTS

Indoor Unit

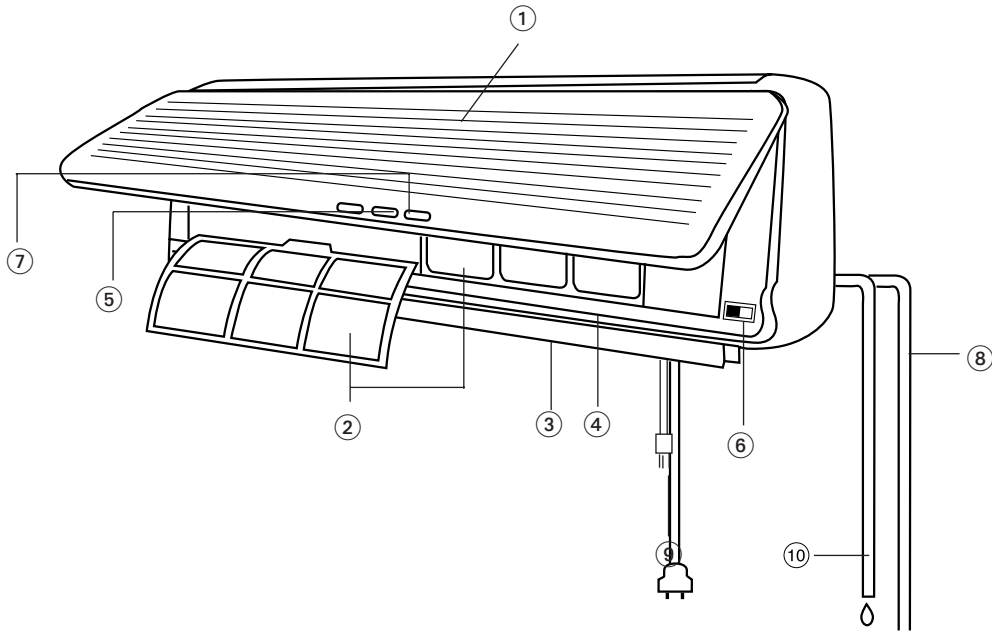

① Front Panel

Air is taken in here.

② Air Filter

Removes all dirt and dust from the air.

③ Air flow-direction Louvers

Control airflow in the vertical (up-down) direction.

**④ Right-left Louvers
(behind Air flow-direction Louvers)**

Control airflow in the horizontal (right-left) direction.

⑤ Operating Control Panel

⑥ POWER SWITCH

Switch to connect or break power supply.

⑦ Indicator Lamps

These indicator lamps show the current operating status.

⑧ Pipe Unit

⑨ Power Plug

⑩ Drain Hose

Moisture condensed from the air during Cooling and Drying operations is drained here.

Indicator Lamps

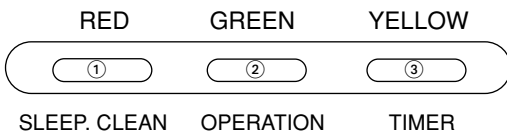

① SLEEP, AIR CLEAN INDICATOR (RED)

- Lights when sleep function or negative ion generation function is operating.
- Flashes quickly means indoor unit defrost.

② OPERATION INDICATOR (GREEN)

- Lights when unit is operating.
- Flashes for about twenty second when power re-start.

③ TIMER INDICATOR (YELLOW)

- Lights during TIMER operation.
- Flashes when system protection function is operating.

Operating Control Panel

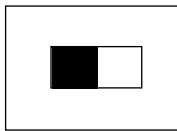
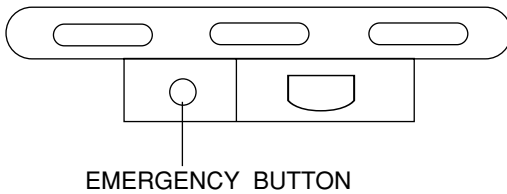

① EMERGENCY BUTTON

When the R/C is broken or lost, you can use the emergency button to start the A/C. The running mode is MASTER control AUTO, FAN control AUTO and AIR FLOW DIRECTION control AUTO.

The emergency button can also be used at manufacture and installation. And to test whether the compressor, for can work normally or not. Press the button two seconds to start the test when air conditioner is POWER OFF. To avoid the user using this function incorrectly. The unit will operate to AUTO model after thirty minutes.

② POWER SWITCH

ON :Set to this position when using the unit.

OFF: Set to this position when not using the unit for an extended period of time.

NAME AND FUNCTION OF PARTS

Remote Controller

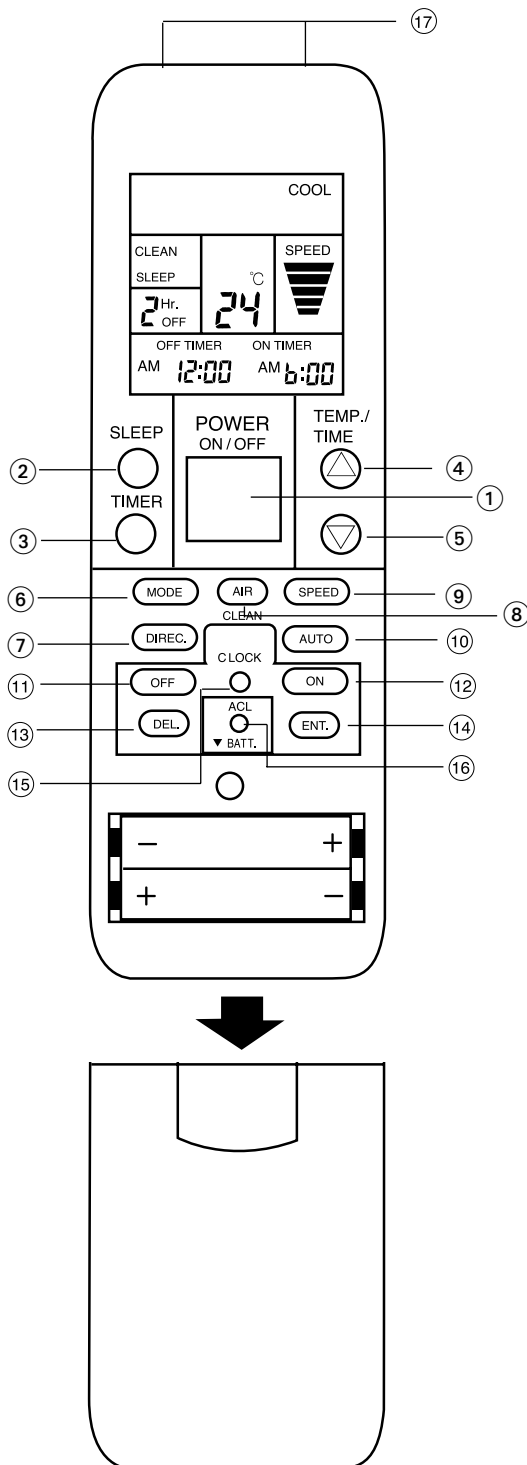

- ① **POWER ON/OFF button**
Press to start and stop operation.
- ② **SLEEP button**
Press to use sleep function mode. It function automatically to modify the thermostat setting in accordance with the time setting.
- ③ **TIMER ADJUST button (1HR-9HR)**
Use to quickly set the desired operating time (1hr-9hr).
- ④ **TEMP/TIME button (UP)**
Press to set the unit's thermostat and clock. (increase)
- ⑤ **TEMP/TIME button (DOWN)**
Press to set the unit's thermostat and clock. (decrease)
- ⑥ **MODE CONTROL button**
Press to set the various operating models (AUTO , COOL , DRY , FAN, HEAT)
- ⑦ **AIRFLOW DIRECTION button**
Use to adjust the airflow vertical direction (AUTO , DIREC .1 , DIREC .2 , DIREC .3 , DIREC .4 , DIREC. 5)
- ⑧ **AIR CLEAN button**
Press to generate negative ion and to purify the room air.
- ⑨ **FAN CONTROL button**
Press to select the fan speed (AUTO, LOW, MEDIUM, HIGH)
- ⑩ **AIRFLOW DIRECTION AUTO**
Press to set the airflow direction AUTO.
- ⑪ **OFF TIMER button**
Set to the desired time until you wish operation to stop.
- ⑫ **ON TIMER button**
Set to the desired time until you wish operation to start.
- ⑬ **TIMER CANCEL button**
Use to cancel the timer set condition.
- ⑭ **TIMER CONFIRM button**
Use to confirm the timer set condition.
- ⑮ **CLOCK SET button**
Use to adjust the current time.
- ⑯ **ACL button**
Use to reset all the user set and return to original set condition.
- ⑰ **Signal Transmitter**
Control signals are sent to the air conditioner from here.

NAME AND FUNCTION OF PARTS

Remote Controller Display

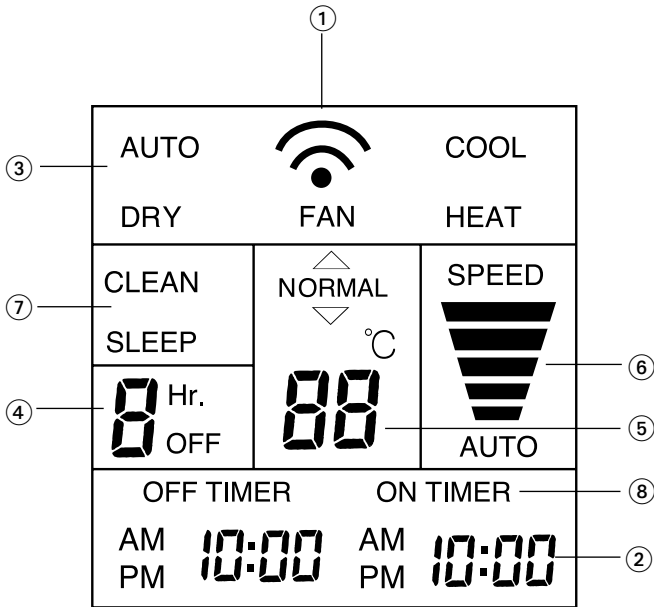

* The accompanying illustration depicts the control display with all indicators lighted; in actual use, however, only those indicators currently required are displayed.

- ① **Transmit Indicator**
This indicator is displayed when a signal is sent to the air conditioner.
- ② **Clock Display**
Indicate either the current time or the timer setting (AM, PM, from 1:00 to 12:59).
- ③ **Operation Mode Display**
Display the operation mode (COOL , etc.).
- ④ **Timer Adjust Display**
Display the desired operating time.
- ⑤ **Set Temperature Display**
Display the thermostat setting.
- ⑥ **Fan Speed Display**
Display the current fan speed.
- ⑦ **Sleep and Air Clean**
Display the sleep and negative ion generation function have been set.
- ⑧ **Timer Mode Display**
Display the conditions of current time, OFF TIMER, ON TIMER.

- Signals will not be transmitted properly if a wall, curtain, or other object is between the air conditioner and the remote control unit.
- The air conditioner may fail to operate properly if strong direct light is allowed to strike the signal receiver. Use a curtain to shade strong sunlight from windows, and place strong lamps at a distance away from the signal receiver.
- If another electric appliance is operated by the remote control unit move the appliance away or consult with authorized service personnel.

- Do not place the remote control unit in locations where it may be subjected to heat from direct sunlight or from heating apparatus.
- Do not subject the remote control unit to strong impacts, and do not allow water or other liquids to splash on it.
- When the remote control unit is used in rooms furnished with instant-lighting type fluorescent lamps, the air conditioner may fail to receive control signals correctly. Consult with authorized service personnel when purchasing a new fluorescent lamp.

PREPARATION

Turn on the Power

- 1 Connect the power plug to an electrical point.

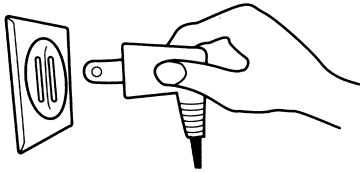

Connect securely, without looseness.

- 2 Open the front panel.

- 3 Set the POWER switch to ON.

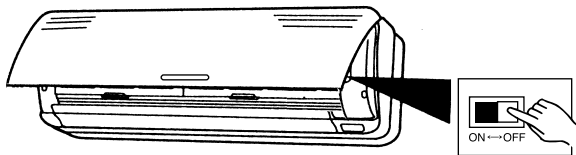

- 4 Close the front panel.

Opening/closing the front panel

- ① Use two hands to pull the lower edges of front panel forward about 30°.
- ② Push the front panel upward with two hands and lift off the panel.

Do not operate the unit with the front panel open, since malfunctions may result.

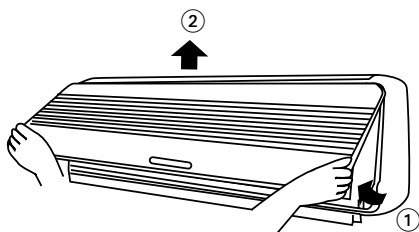

Hook the front panel top hooks to the front panel grille top holes and press the both lower sides of the front panel. Then the grille locks into place.

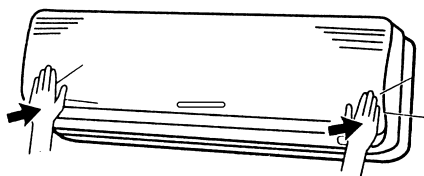

Prepare the Remote Control Unit

Load batteries in the remote control unit and set the clock to the current time.

Load Batteries (R03 / LR03 × 2)

- 1 Press and slide the battery compartment lid on the bottom to open it.

Slide in the direction of the arrow while pressing the  place.

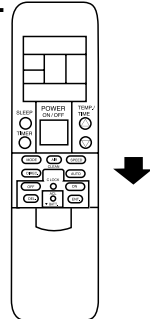

- 2 Insert batteries.

Be sure to align the battery polarities (\oplus/\ominus) correctly.

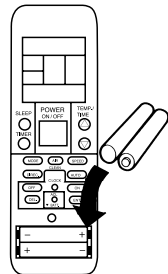

- 3 Close the battery compartment lid.

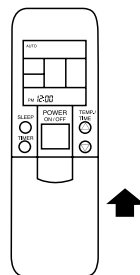

CAUTION!

- Take precautions to prevent infants from accidentally swallowing batteries.
- When not using the remote control unit for an extended period, remove the batteries to avoid possible leakage and damage to the unit.
- ※ If leaking battery fluid comes in contact with your skin, eyes, or mouth, immediately wash with copious amounts of water, and consult your physician.
- Dead batteries should be removed quickly and disposed of properly, either by placing in a public battery collection receptacle, or by returning to a properly equipped dealer.
- Do not attempt to recharge dry batteries.

NOTE:

- Never mix new and used batteries, or batteries of different types.
- Batteries should last about one year under normal use. If the remote control unit's operating range becomes appreciably reduced, replace the batteries and press the ACL button with the tip of a ball-point pen or other small object.

PREPARATION

Set the Current Time

1 Press the **TIME ADJUST** button.

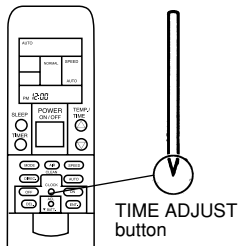

(Remote Control Unit Display)

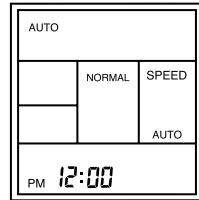

The AM, PM will flash.

Use the tip of a ball-point pen or other small object to press the button.

2 Use the Δ / ∇ **TIME SET** buttons to adjust the clock to the current time.

Δ button: Press to advance the time.

∇ button: Press to reverse the time.

(Each time the buttons are pressed, the time will be advance/reversed in one-minute increments; hold the buttons depressed to change the time quickly in one-minute increments every 0.1 second).

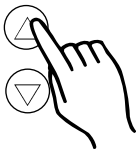

Example:
When the clock is set to 11:30 AM.

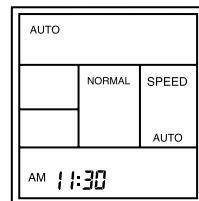

3 Press the **TIME ADJUST** button again.

This completes the time setting and starts the clock.

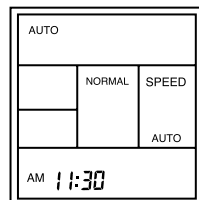
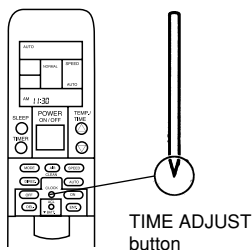

The AM, PM, display stops flashing and lights steadily.

To Use the Remote Control Unit

- The remote control unit must be pointed at signal receiver to operate correctly.
- When a signal is properly received by the air conditioner, a beeping sound will be heard.
- If no beep is heard, press the remote control unit button again.

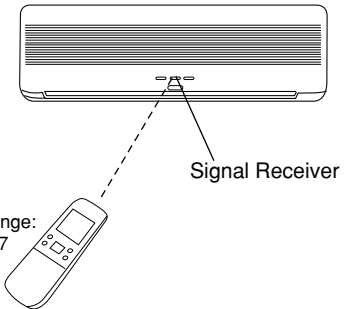

Remote Control Unit Holder

- This holder can be mounted on a wall or in a convenient position to allow operation.
- If the holder is installed in a location allowing signals to be received by the air conditioner, the remote control unit can be used without removing it from the holder.

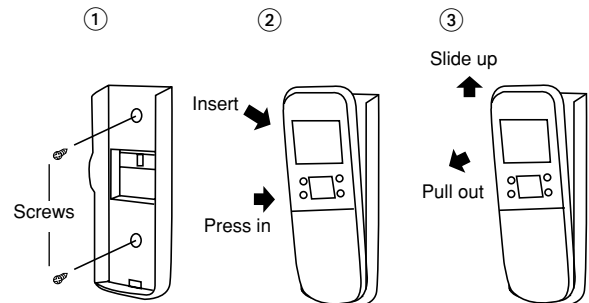

- ① Mount the Holder.
- ② Set the remote control unit .
- ③ To remove the remote control unit (for hand use).

AUTOMATIC OPERATION

To Select AUTOMATIC Operation

- 1 Press the **POWER ON/OFF** button.
The air conditioner will start operation.

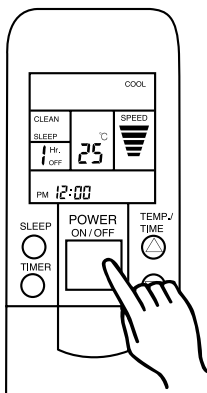

- 2 Press the **MODE CONTROL** button to select **AUTO**.

The operating mode "AUTO" will appear alone in the display. The transmit indicator will flash to indicate the command has been sent, and the signal transmits after releasing button. While set to AUTO mode, controller chooses the operating mode depending on room temperature. These status is set as shown.

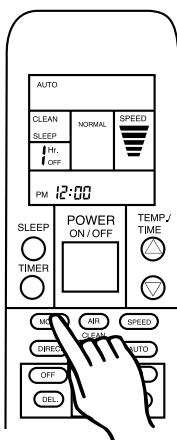

Cooling	25°C above
Dry	20°C ~ 25°C
Heating	20°C below

	Cooling
25°C	-----
	Dry
20°C	-----
	Heating

About Automatic Operation

- Depending on the room temperature at the time operation begins, the operating mode will be switched automatically as shown. Also, depending on the operating mode, the room temperature setting will cause the "normal" temperature to be set as shown.

- Once the operating mode has been set, the mode will not change even if the room temperature changes.
- In the DRY mode, the fan will operate slowly to prevent room humidity from rising.

AUTOMATIC OPERATION

To Change the Fan Speed

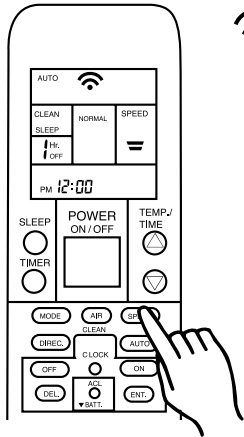

- Display 0.5 second
- Flash one time/ second



Press the SPEED button.

Each time the button is pressed, the fan speed changes in sequence:

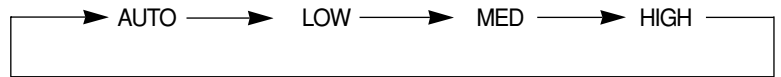

About 0.5 second later, the entire display will reappear.

When the SPEED is set to AUTO:

The fan speed switches in accordance with the difference of room temperature and setting temperature.

As the difference between the thermostat setting and actual room temperature is reduced, the fan speed becomes slower. The operation is as following:

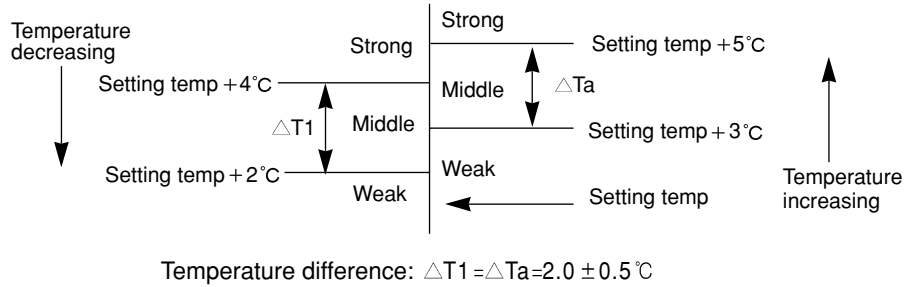
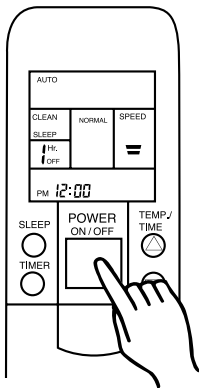

To Stop Operation

Press the POWER ON/OFF button.

MODE OPERATION (COOL , DRY , FAN, HEAT)

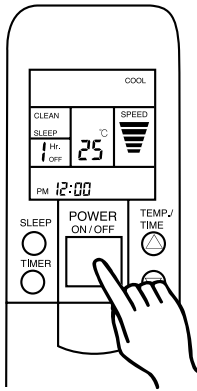

To Select Mode Operation

- 1 Press the **POWER ON/OFF** button.
The air conditioner will start operation.

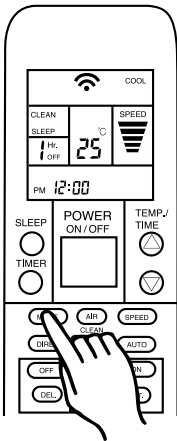

- 2 Press the **MODE CONTROL** button to select the desired mode.

Each time the button is pressed, the mode will change in the sequence.

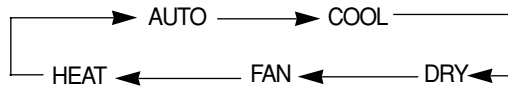

Example: When set to COOL

About Mode Operation

COOL

- Use to cool your room.

HEAT

- Use to warm your room.
- Set the thermostat to a temperature setting that is higher than the current room temperature. The HEAT mode will not operate if the thermostat is set lower than the actual room temperature.

DRY

- Use for gently cooling while dehumidifying your room.
- You cannot heat the room during DRY mode.
- The fan speed cannot be changed manually when DRY mode has been selected.

During COOL / DRY mode:

- Set the thermostat to a temperature setting that is lower than the current room temperature. The COOL and DRY modes will not operate if the thermostat is set higher than the actual room temperature (in COOL mode, the fan will operate alone).

FAN

- When using a space heater to heat the room, using the air conditioner's FAN setting will help prevent warm air from collecting near the ceiling, and thus assist in distributing warm air evenly throughout the room.

During FAN mode:

- You cannot use the unit to heat and cool your room.

COOL MODE

- 1 When the fan speed set to "AUTO", COOL mode operation is as below:

Temperature decreasing

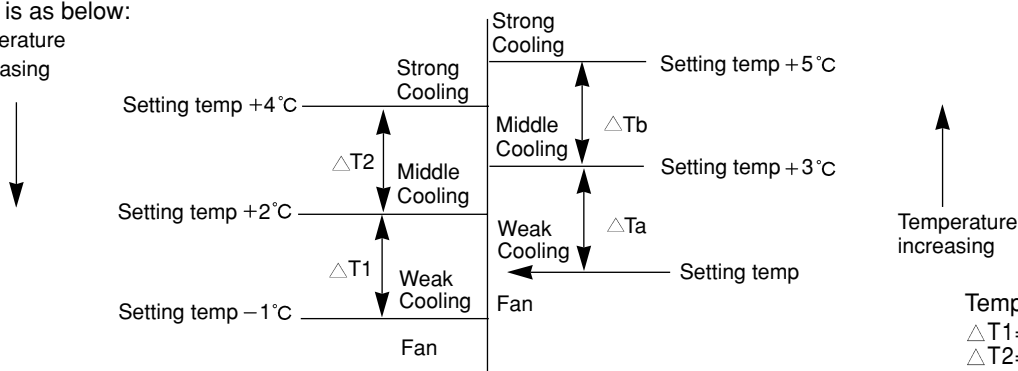

MODE OPERATION (COOL , DRY , FAN, HEAT)

2 When the fan speed doesn't set to "AUTO ", COOL mode operation is as below:

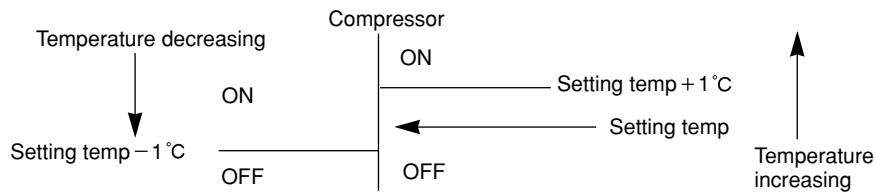

HEAT MODE

1 When the fan speed set to "AUTO", HEAT mode operates as below:

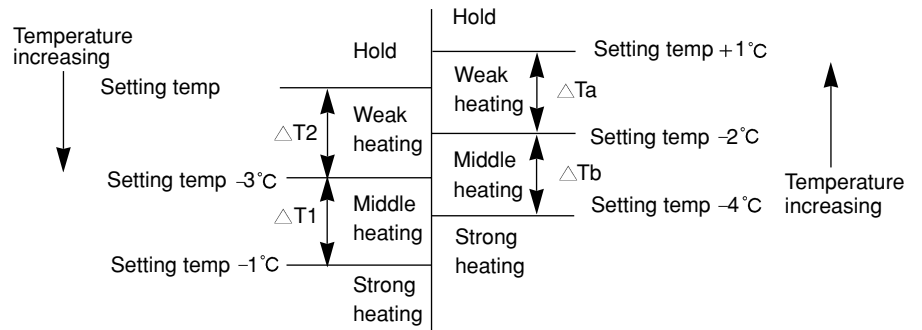

2 When the fan speed doesn't set to "AUTO " HEAT mode operation is as below :

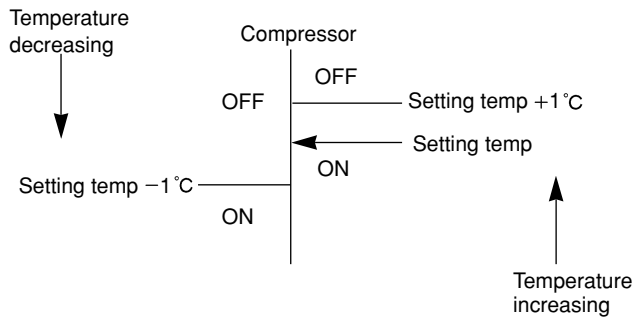

Temperature difference: $\Delta T_1 = \Delta T_a = 3.0 \pm 0.5^\circ\text{C}$
 $\Delta T_2 = \Delta T_b = 2.0 \pm 0.5^\circ\text{C}$

DRY MODE

The operating mode is as following:
Air conditioner operates with COOL mode when the room temperature is not reach setting temperature.
Air conditioner operates with DRY mode until the room temperature goes down below setting temperature.
In this time, fan speed changes into middle level.

1 The DRY operation is the ON/OFF action of compressor. It is used for dehumidify during the compressor "ON", and recover time to room temperature during the compressor "OFF".

2 Operation is shown as below:

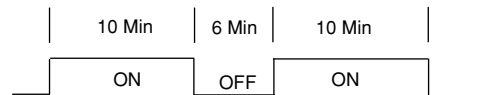

FAN MODE

When use FAN SPEED function, it can select STRONG, MIDDLE and WEAK and AUTO levels.

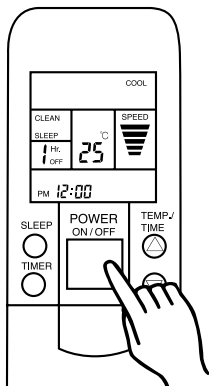

To Set the Fan Speed

See the "AUTOMATIC OPERATION" section.

To Stop Operation

Press the POWER ON/ OFF button.

TEMP. / TIME ADJUSTMENT

TEMP. / TIME buttons

- ⬆ button : Press to increase the setting.
- ⬇ button : Press to decrease the setting.
- ⬆ TEMP./ TIME increase button.

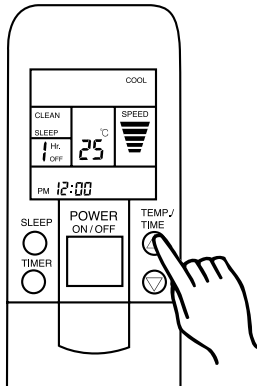

1 Temperature adjustment:

- a. Except for time adjustment and quick timer setting, the button is used "temp. setting increase button". Each time the button is pressed, temperature would increase in 1 °C increments. Keep pressing the button, the value would increase 1 °C for every 0.3 second after the first second.
- b. The number display sequence is as below:
16 → 17 → 18 → → 30
- c. When mode choices AUTO, setting can only set Normal temp. - 2 °C → Normal temp. → Normal temp. + 2 °C

2 Time adjustment:

- a. When use the ON TIMER, OFF TIMER, current time adjustment function, the button is used "time increase button".
- b. In the current time adjustment, each time the button is pressed, the time increases 1 minute. After accumulates to 59 minutes, minute returns to "0", hour adds "1". The other increase is similar.
- c. In the ON TIMER, OFF TIMER function, each time the button is pressed, the time increases 10 minutes. After accumulates to 50 minutes, minute returns to "0", hour adds "1". The other increase is similar. Keep pressing this button for more than 1 second, every 0.1 second increases "1". Switch cycle is as below:



⬇ TEMP./TIME decrease button

1 Temperature adjustment

- a. Except for time adjustment and quick timer setting, the button is used "temp. setting decrease button". Each time the button is pressed, temperature would decrease in 1 °C increments. Keep pressing the button, the value would decrease 1 °C for every 0.3 second after the first second.
- b. The number display sequence is as below:
30 → → 18 → 17 → 16
- c. When mode choices AUTO, setting can only set Normal temp. + 2 °C → Normal temp. → Normal temp. - 2 °C

2 Time adjustment

- a. When use the ON TIMER, OFF TIMER, current time adjustment functions, the button is used "time decrease button".
- b. In the current time adjustment, each time the button is pressed, the time decreases 1 minute. After go down to "00" minutes, minute changes to "59", hour decreases 1. The other decrease is similar.
- c. In the ON TIMER, OFF TIMER function, each time the button is pressed, the time decreases 10 minute. After decreases to "00", minute changes to "59", hour decreases "1". The other decrease is similar. Keep pressing this button for more than 1 second, every 0.1 second decreases 1. Switch cycle is as below:

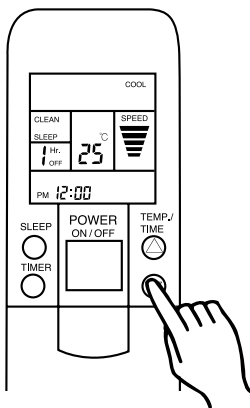
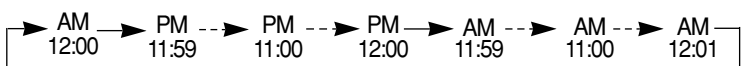

AIR DIRECTION ADJUSTMENT

- Use the remote control unit's AIR FLOW DIRECTION button to adjust the up-down direction of airflow. (Left-right air direction is changed by manually moving the air louvers).
- Begin unit operation and confirm that the airflow-direction louvers are stopped before setting the airflow-direction.



WARNING!

- Do not put fingers or other objects into the air louvers; an internal fan operates at high speed and could result in personal injury or damage.
- Do not operate the air conditioner with the airflow louvers blocked, since malfunction could result.

Automatic Airflow-Direction Adjustment

1 The signal immediately transmits after pressing "AUTO " button.

Non auto swing → Auto swing

- The button is effective only in the condition of POWER ON .
- When in auto swing condition already, pressing this button is no use.

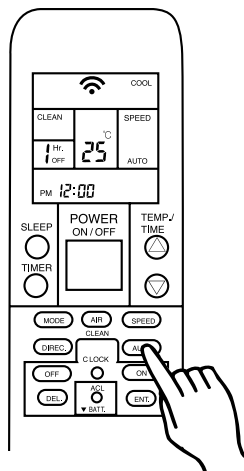

2 The signal immediately transmits after pressing "DIREC. " button.

- The button is effective only in the condition of POWER ON .
- Operating order is as below:
Auto swing → Manual swing 1 → Manual swing 2 → Manual swing 3 → Manual swing 4 → Manual swing 5 → Manual swing 4
- If keeps pressing the "DIREC." button, the signal changes continuously until releasing it.

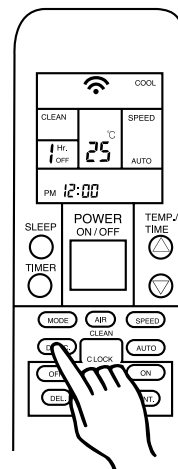

NOTE:

- Always use the remote control unit's airflow-direction button to change the position of the up-down airflow-direction louvers. Do not attempt to set louvers by hand, since it may result in improper operation. In this case, stop the air conditioner temporarily and then restart to return the louvers to proper operation.
- Never operate the air conditioner when the up-down airflow-direction louvers are closed.

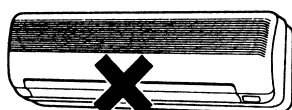

Do not operate when closed!

- When the operating mode is changed, the up-down airflow-direction louvers will automatically change to their standard direction.
- In the cooling and drying modes, dew may condense around and drop from the air outlet ports when the louvers are set to the other cooling range. As a result, we recommend that this position be used only for brief periods.
- A certain time interval may be required after pressing the remote control unit's airflow-direction button unit the louvers are set to the desired position. During that interval, the airflow-direction button will not respond, even if pressed.
- When the air conditioner operation is stopped, the up-down airflow direction louvers automatically move to close the outlet vent.

AIR DIRECTION ADJUSTMENT

Louver Swing Degree Adjustment

- 1 First time to insert power plug or turn off power, louver would swing up at utmost angle and back to cover whole air flow outlet.
- 2 When press "Auto Swing" button:
 - a. Louvers swing down and open to utmost angle. This step reset the setting angle.
 - b. Louvers swing up 35° at cooling mode and 10° at heating mode .
 - c. Louvers swing up and down 45° at cooling mode. At heating mode, louvers turn back 10° to initial setting angle after initial five swing times .
 - d. repeat the c. step.
- 3 When press "DIREC." button each time, louvers swing 10 degree.
 - a. Louvers swing down and open to utmost angle. This step reset the setting angle.
 - b. Louvers swing up 35° at cooling mode and 10° at heating mode.
 - c. Louvers swing 10 degree when press "DIREC." button each time. (from 35° to 75° at cooling mode, from 10° to 50° at heating mode).
 - d. If keep pressing this button, louver would continue move to adjust airflow direction until release this button.

NOTE:

- In order to heighten the efficiency of cooling and drying modes, the airflow-direction louvers should be set within the following ranges:

Horizontal, slight downward diagonal.

Adjustment the Right-Left Direction

- Manually adjust the right-left louvers to the desired direction.

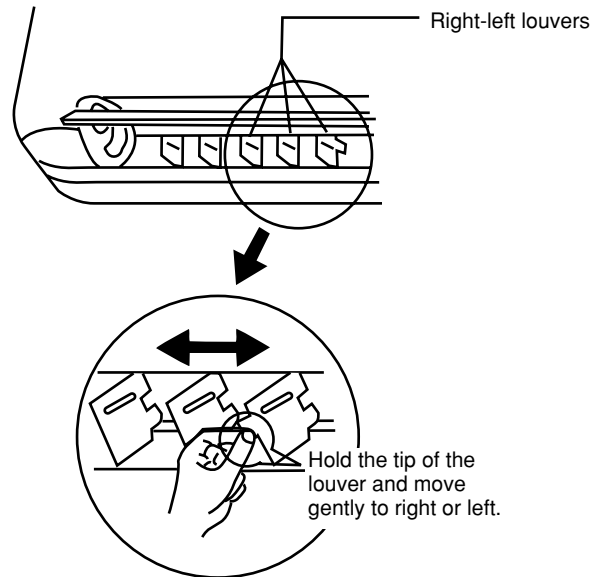

TIMER OPERATION

Before using the timer function, be sure that the remote controller is set to the correct current time.

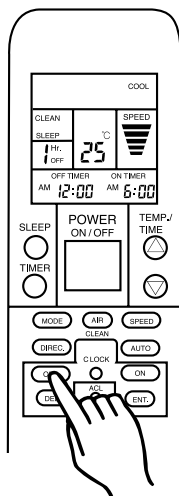
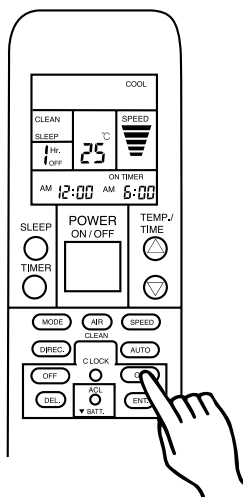

ON TIMER (Begins air conditioner operation at the set time)

- 1 When the " ON TIMER " button is pressed, "ON TIMER" will be displayed and flashed, it means entering the "ON TIMER" setting. Meanwhile, can use " \triangle ∇ " buttons to adjust the desired time.
- 2 When the adjustment is finished, press "ENT." button once. Then "ON TIMER" signal stop flashing and setting is confirmed.
- 3 If you don't press any button over 30 seconds, the setting procedure will be stopped and return to current time .

OFF TIMER (Stops the air conditioner operation at the set time)

- 1 When the " OFF TIMER " button is pressed, "OFF TIMER" will be displayed and flashed, it means entering the "OFF TIMER" setting. Meanwhile, can use " \triangle ∇ " buttons to adjust the desired time.
- 2 When the adjustment is finished, press "ENT." button once. Then "OFF TIMER" signal stop flashing and setting is confirmed.
- 3 If you don't press any button over 30 seconds, the setting procedure will be stopped and return to current time.

To Cancel the Timer

- 1 Press " ON TIMER " and "OFF TIMER" . The display of " ON TIMER " and "OFF TIMER" will be flashed.
- 2 Press " DEL. " button . The signal " ON TIMER " and "OFF TIMER" will disappear. And display the current time. That means the cancel step is finished. (The unit will switch to non-stop operation)

To Stop Air Conditioner Operation while the Timer is Operating

Press the POWER ON/OFF button.

To Change Operating Conditions

If you wish to change operating conditions (Mode, Fan Speed, Thermostat Setting, Air flow direction), after making the timer setting wait until the entire display reappears, then press the appropriate buttons to change the operating condition desired.

SLEEP OPERATION

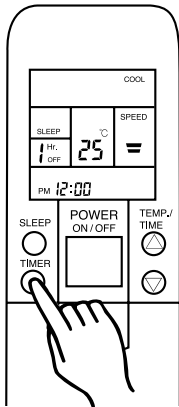
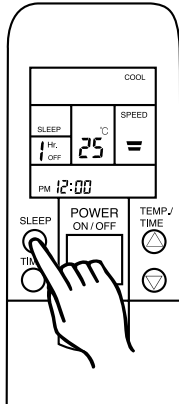

To Use the SLEEP Function

While the air conditioner is operating or stopped, press the SLEEP button. The indoor unit's red lamp lights.

- 1 The function is effective only at POWER ON status.
- 2 Sleep operation is not valid on FAN mode.
- 3 Switch sequence is as below:

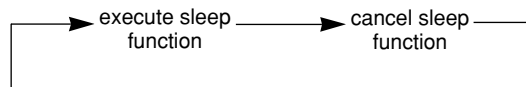

To Change the Timer Settings

- 1 Press the TIMER button to adjust quickly operating time.
- 2 Press the ON TIMER and OFF TIMER functions to adjust the set time of start and stop air conditioner.

TIMER button (Hours Adjustment)

- 1 The function is effective only at POWER ON status.
- 2 When press the TIMER button, LCD displays "1 Hr. OFF". Setting will increase by 1 hour by pressing TIMER button.
- 3 Setting cycle in hours is as below :

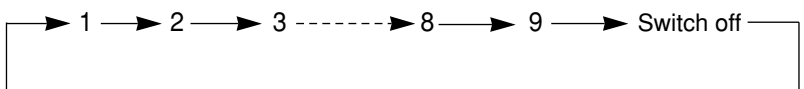

- 4 When the set time is adjusted to "SWITCH OFF" status, it means the TIMER setting is canceled.

To Cancel the Timer:

See 「TIMER OPERATION 」

To Stop the Air Conditioner During Timer Operation:

See 「TIMER OPERATION 」

SLEEP OPERATION

About the SLEEP FUNCTION

To prevent excessive cooling during sleep, the SLEEP function automatically modifies the thermostat setting in accordance with the time setting. When the set time has elapsed, the air conditioner completely stops.

● During Cooling/Drying operation:

When the SLEEP is set, the thermostat setting is automatically raised 1 °C every sixty minutes. When the thermostat has been raised a total of 2 °C, the thermostat setting at that time is maintained until the set time has elapsed, at which time the air conditioner automatically turns off.

● During heating operation:

When the SLEEP is set, the thermostat setting is automatically lowered 1 °C every sixty minutes. When the thermostat has been lowered a total of 2 °C, the thermostat setting at that time is maintained until the set time has elapsed, at which time the air conditioner automatically turns off.

● Operation Model:

1. While in the cooling model, whenever the SLEEP function is started, the thermostat setting is automatically raised 1 °C, Setting is raised 1 °C again after sixty minutes. The total raise is 2 °C °.
2. While in the heating model, whenever the SLEEP function is started, the thermostat setting is automatically lowered 1 °C, Setting is lowered 1 °C again after sixty minutes. The total is lowered 2 °C °.
3. SLEEP function is not valid on FAN mode.

SLEEP timer setting (cooling)

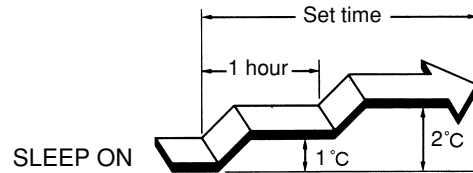

SLEEP timer setting (heating)

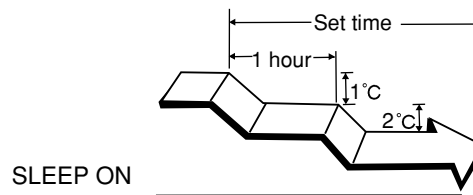

AIR CLEAN OPERATION

Negative Ion Generation Setting

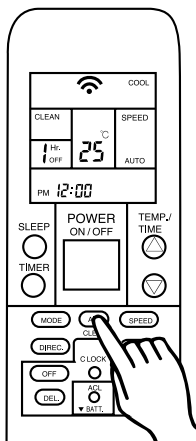

- 1 After press the "AIR CLEAN " button , the negative ion generation function is started. Remote controller displays "CLEAN ".

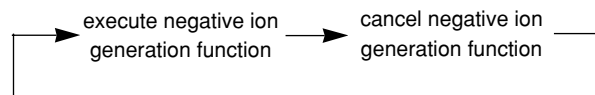

- 2 The function is valid only in POWER ON status.

CARE AND MAINTENANCE



CAUTION!

- Before cleaning the unit, be sure to stop the unit and disconnect the power supply.
1. Disconnect the power plug.
 2. Turn off the electrical breaker.
- A fan operates at high speed inside the unit, and personal injury could result.

When cleaning the air conditioner, disconnect the power plug or turn off the electrical breaker.

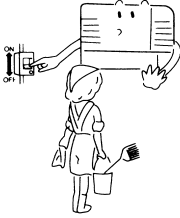

Never use water that is hotter than 40 °C. The body may warp or change colour.



The unit can be damaged by gasoline, benzene, thinners, insecticides and other chemical agents.

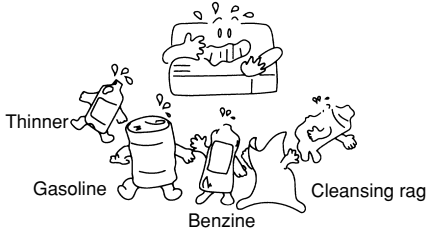

Do not use inflammable sprays such as lacquer or hair spray the air conditioner.

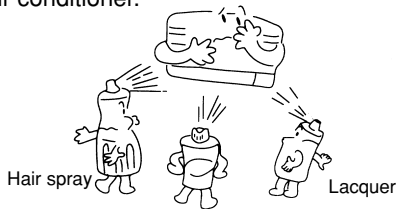

Cleaning the Indoor Unit

Clean the indoor unit by wiping with a cloth dipped in cool or warm water, then wipe with another soft, clean, dry cloth.

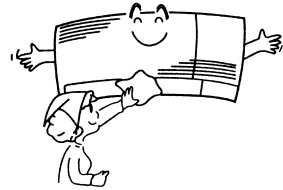

When Not Using the Unit for Extended Periods (One Month or More)

Operate the unit on fan mode for about one-half day on a day with clear weather, to assure that the internal parts are dry.



CAUTION!

When not using the unit for extended periods, disconnect the power plug for safety.

- When a plug is left connected, dust may collect on the blades, leading to smoke and fire hazard.

Check the Power Cord

Check the power cord occasionally to confirm that it is not damaged by cuts or abrasions. If you discover damage to the cord, consult authorized service personnel.

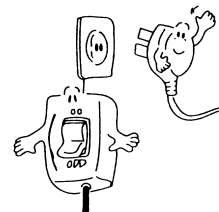

Inspections and Repairs

Depending on the conditions of use, the internal parts of an air conditioner will become dirty after about two or three seasons of use, and performance may be affected. For this reason, regular professional maintenance is recommended. Consult authorized service personnel.

CARE AND MAINTENANCE

Cleaning the front panel

Removing the front panel

1. Use two hands to pull the lower edges of front panel forward about 30°.
2. Push the front panel upward with two hands and lift off the panel.

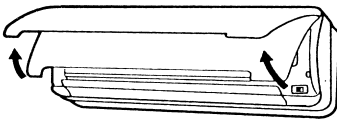

3. Lift up the front panel until it can be removed (the grille cannot be removed unless it is raised sufficiently).

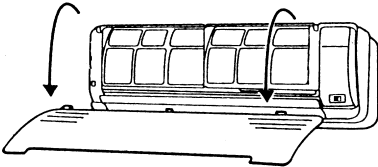

Cleaning the front panel

Use a vacuum cleaner to remove dust accumulations, then wipe the grille with a clean cloth dipped in warm water; wipe with a clean dry cloth to remove any water.

Installing the front panel

1. Hold the front panel horizontally and fasten the two hooks on the front panel grille.

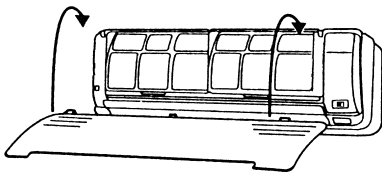

2. Hook the panel top hooks to the grille top holes and press the both lower sides of the front panel. Then, the front panel locks into place.

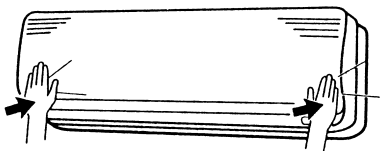

Cleaning the Air Filter

If dirt is allowed to collect in the air filter, the airflow will be reduced, leading to reduced performance, and increased operation noise. Be sure to clean the filters at the beginning of the operating season, and about every two weeks during periods of frequent operation.

Removing the Air Filter

1. Remove the front panel.
2. Hold on the air filter handles and pull up slightly to release the two lower hooks. Then pull the air filter down and out.

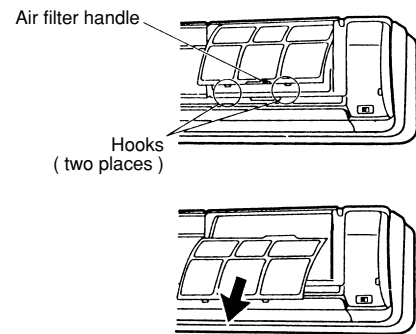

Cleaning the Air Filter

Either use a vacuum cleaner to remove accumulated dust, or wash in a neutral detergent solution.

When washing the filter, allow it to dry well in a shaded location before reinstalling it in the air conditioner.

Installing the Air Filter

1. Align the air filter with the ditch of the panel and press in until it stops.
2. Insert the air filter's two hooks in the holes in the front panel grille and press in.
3. Close the front panel.

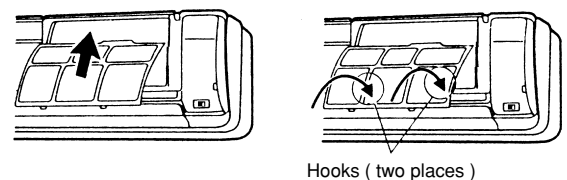

Hooks (two places)



TROUBLE SHOOTING



WARNING!

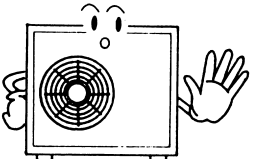
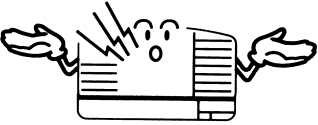

In the event of a malfunction (burning smell, etc.), immediately stop operation, disconnect the power plug, and consult authorized service personnel. Merely turning off the unit's power switch will not completely disconnect the unit from the power source. Always be sure to disconnect the power plug and turn off your circuit breaker to ensure that power is completely off.

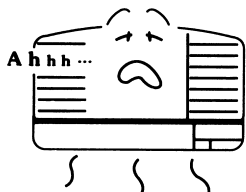
Before requesting service, perform the following checks:

	Symptom	Problem	See Page
NORMAL FUNCTIONS	Doesn't operate immediately: 	<ul style="list-style-type: none"> ● If the unit is stopped and then immediately started again, the compressor will not operate for about 3 minutes, in order to prevent fuse blowouts. ● Whenever the power plug is disconnected and then reconnected to a power outlet, the protection circuit will operate for about 3 minutes, preventing unit operation during that period. 	—
	Noise is heard: 	<ul style="list-style-type: none"> ● During operation and immediately after stopping the unit, the sound of water flowing in the air conditioner's piping may be heard. Also, noise may be particularly noticeable for about 2 to 3 minutes after starting operation (sound of coolant flowing). ● During operation, a slight squeaking sound may be heard. This is the result of minute expansion and contraction of the front cover due to temperature changes. 	—
	Smells:	<ul style="list-style-type: none"> ● Some smell may be emitted from the indoor unit. This smell is the result of room smells (furniture, tobacco, ect.) which have been taken into the air conditioner. 	—
	Mist or steam are emitted: 	<ul style="list-style-type: none"> ● During Cooling or Drying operation, a thin mist may be seen emitted from the indoor unit. This results from the sudden Cooling of room air by the air emitted from the air conditioner, resulting in condensation and misting. 	—
	Airflow is weak or stops: 	<ul style="list-style-type: none"> ● The fan may operate at very low speed during Drying mode or when the unit is monitoring the room's temperature. 	15
		<ul style="list-style-type: none"> ● In the monitor AUTO operation, the fan will operate at very low speed. 	12

**WARNING!**

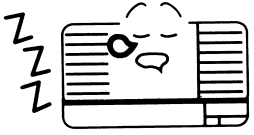
Consult authorized service personnel for any repairs.

	Symptom	Items to Check	See Page
CHECK ONCE MORE	Doesn't operate at all: 	<ul style="list-style-type: none">● Is the power plug disconnected from its outlet ?● Has there been a power failure ?● Has a fuse blown out, or a circuit breaker been tripped ?	—
		<ul style="list-style-type: none">● Is the main power switch set to the OFF position?	10
		<ul style="list-style-type: none">● Is the timer operating ?	19-21
	Poor Cooling performance: 	<ul style="list-style-type: none">● Is the air filter dirty ?● Are the air conditioner's intake grille or outlet port blocked ?● Did you adjust the room temperature settings (thermostat) correctly ?● Is there a window or door open?● In the case of cooling operation, is a window allowing bright sunlight to enter ? (Close the curtains.)● In the case of Cooling operation, are there heating apparatus or computers inside the room, or are there too many people in the room ?	—

OPERATION DETAILS

Please read and understand following details regarding this air conditioner.

Malfunction

Nearby lightning or use of a mobile radio (short wave, etc.) may result in malfunction. In this case, disconnect the power plug from its outlet and connect it again, then use the remote control unit to resume operation.

Auto Restart

- The air conditioner power has been interrupted by a power failure. The air conditioner will then restart automatically in its previous mode when the power is restored.
- Operated by settings before the power failure. Then, the airflow-direction louvers will automatically change to their standard direction.
- If a power failure occurs during timer operation, the timer will be reset and the unit will begin (or stop) operation at the new time setting. In the event that this kind of timer fault occurs, the TIMER indicator will flash.

Temperature and Humidity Range

Permissible ranges of temperature and humidity are as follows:

Cooling Operation	Outdoor temperature: About 18 °C to 46 °C
	Indoor temperature: About 18 °C to 32 °C
	Indoor humidity: About 80% or less. If the unit is used for long periods under conditions of high humidity, water may condense on and drip from the surface of the unit.
Drying Operation	Outdoor temperature: About 18 °C to 46 °C
	Outdoor temperature: About 18 °C to 32 °C
	Indoor humidity: If the unit is used for long periods under conditions of high humidity, water may condense on and drip from the surface of the unit.
Heating Operation	Outdoor temperature: About -5 °C to 21 °C
	Indoor temperature: About below 30 °C

If the unit is used under higher temperature conditions than those noted here, the automatic protection circuit may operate, interrupting the operation. If the unit is used under lower temperature conditions than those noted here, the heat exchanger may freeze, causing water leakage or other malfunction.

- Do not use the air conditioner for any purpose other than room cooling, heating, room drying or fan.